

- LEGEND:**
- PRESSURE SEWER MAIN
 - PRESSURE SEWER RISING MAIN
 - Z 1 500 ZONE NUMBER / PIPE SIZE
 - ZONE / PIPE SIZE CHANGE; FLOW DIRECTION
 - SCHEME BOUNDARY
 - EXISTING DWELLINGS
 - V VACANT LOTS
 - F FUTURE LOTS
 - NON - RESIDENTIAL AREA
 - FUTURE INDUSTRIAL GROWTH AREA
 - FUTURE RESIDENTIAL GROWTH AREA

Site Number	Description	Peak Season Loadings E ³	Peak Season Loadings RL/d	Off Season Loadings ET	Off Season Loadings KL/d	Peak Discharge Modelling Allowance
GRASSY HEAD LOADINGS						
	Grassy Head Residential	23	10.4	23.0	10.4	
	Vacant Lots	3	3.5		0.3	
	Grassy Head Central Park	81	21.0	1.3	0.5	3.0d
	Grassy Head Amenities	13	1.5	1.3	0.5	
2	Tourist Accommodation	5	2.3	1.3	0.5	
3	Yarragginia Adventure Youth Centre	45	20.0	2.3	0.8	0.5d
	GRASSY HEAD PRESSURE SEWER TOTAL	152	68.4	26	12.6	
4	Grassy Head Camp (Seawater Pumping System)	400	190.0	1.0	0.5	17.0d
STUARTS POINT LOADINGS						
	Stuarts Point Residential Existing	332	171.0	332.0	171.0	
	Vacant Lots	12	5.4		0.3	
5	Boating Club	12	5.4	12.0	5.4	
	Stuarts Point Central Park	81	21.0	1.3	0.5	3.0d
6	Stuarts Point Amenities	13	4.5	1.3	0.5	
7	Department of Education School	3	1.4	3.0	1.4	
8	Boating Holes	7	3.2	7.0	3.2	
9	Traffic	3	3.8	3.0	3.8	
10	Shops including butcher, Newsagent, Small Supermarket and Service Station	14	9.3	14.0	9.3	
11	Library and Community Hall	5	2.3	5.0	2.3	
12	Cold Mining and RPS	3	3.4	3.3	0.2	
	STUARTS POINT PRESSURE SEWER TOTAL	536	242.6	436	196.2	
STUARTS POINT FUTURE DEVELOPMENT AREA LOADINGS (Proposed to be connected to future pumping system from Grassy Head Convention Centre)						
13	Future Industrial Growth Area (5 Ha)	50	21.5	51	22.6	
14	North Future Residential Growth Area (15 Ha)	550	252.0	560	252.0	
15	South Future Residential Growth Area (15 Ha)	550	252.0	560	252.0	
FISHERMANS REACH LOADINGS						
	Fishermans Reach Residential	81	34.0	81	34.0	
	Vacant Lots	15	8.8			
	FISHERMANS REACH PRESSURE SEWER TOTAL	102	43.9	87	39.15	
TOTAL		2283	1027.35	1642	738.9	

Drawing No: SK00
 Rev: D
 Date: 19/11/2021
 Scale: NTS

STUARTS POINT MASTERPLAN

FOR INFORMATION ONLY

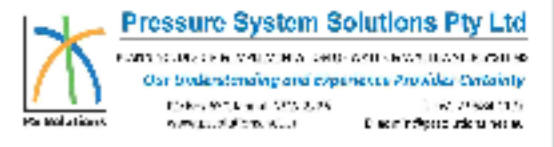

C:\Users\Valued Customer\Documents\210701 Stuarts Point\Street Mains\210624_SK00_SK08-[D].dwg

YARRAHAPINNI
ADVENTIST
YOUTH CENTRE

FOR YARRAHAPINNI
SEWER LAYOUT REFER
TO DRAWING SK201

FOR GRASSY HEAD
CARAVAN PARK SEWER
LAYOUT REFER TO
DRAWING SK301

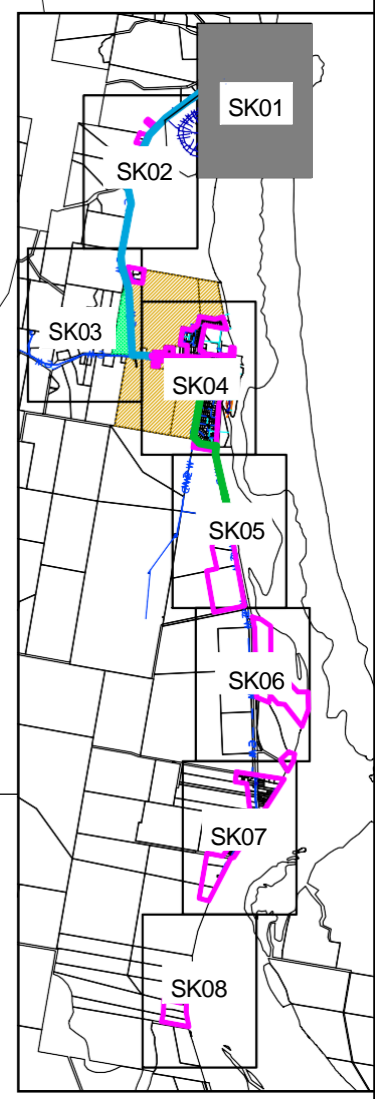
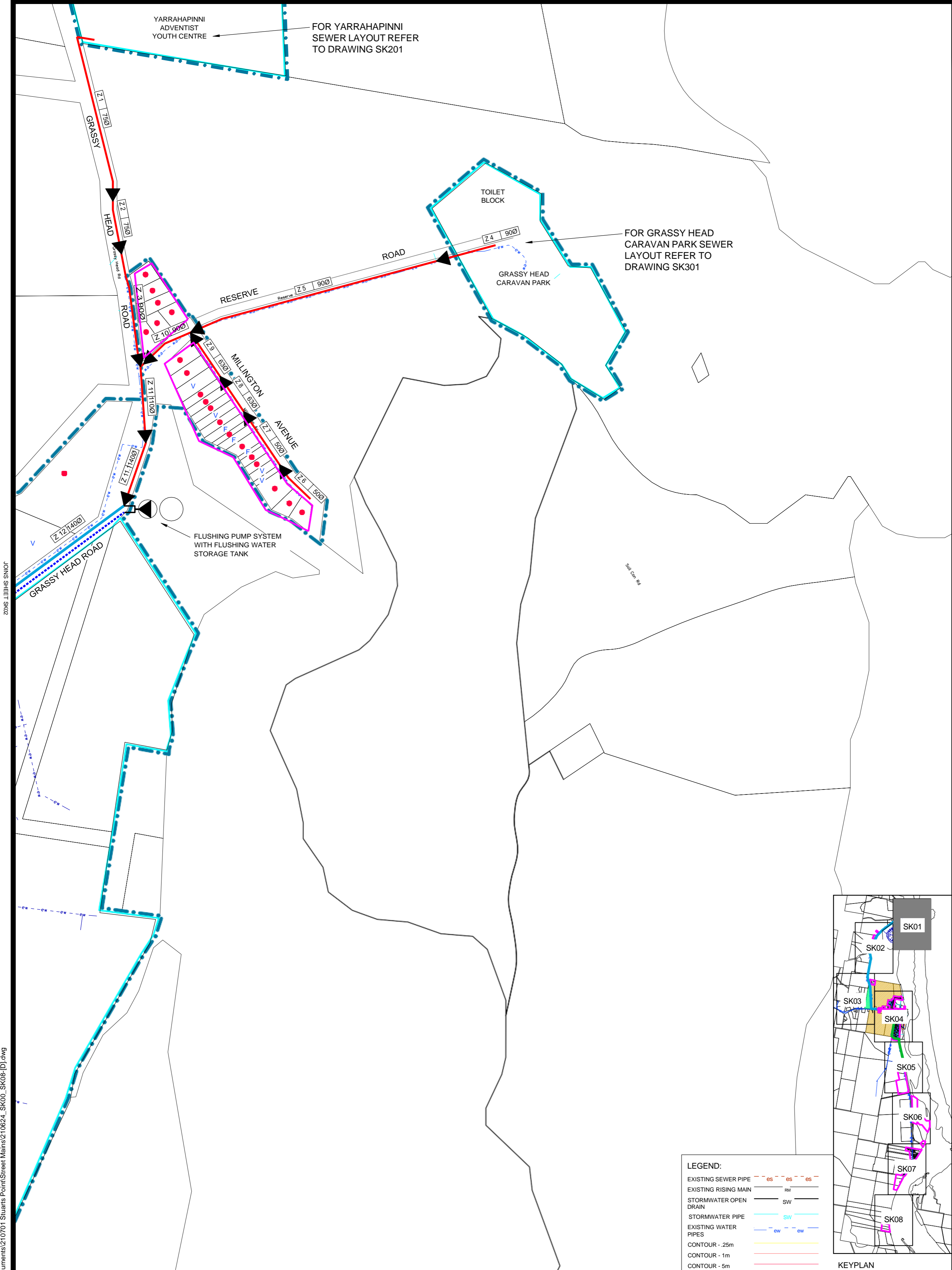

LEGEND:

EXISTING SEWER PIPE	es	es	es
EXISTING RISING MAIN	RM	RM	RM
STORMWATER OPEN DRAIN	SW	SW	SW
STORMWATER PIPE	sw	sw	sw
EXISTING WATER PIPES	ew	ew	ew
CONTOUR - .25m			
CONTOUR - 1m			
CONTOUR - 5m			

KEYPLAN

Drawing No: SK01

Rev: D

Date: 19/11/2021

Scale: 0 20 40 60 80 100m
SCALE 1:2000 AT A1

STUARTS POINT



CONCEPT

2024 SHEET SK01

C:\Users\valued customer\Documents\210701 Stuarsts Point\Street Mains\210624_SK00_SK08-[D].dwg

Saved: 19/11/2021, By: valued customer

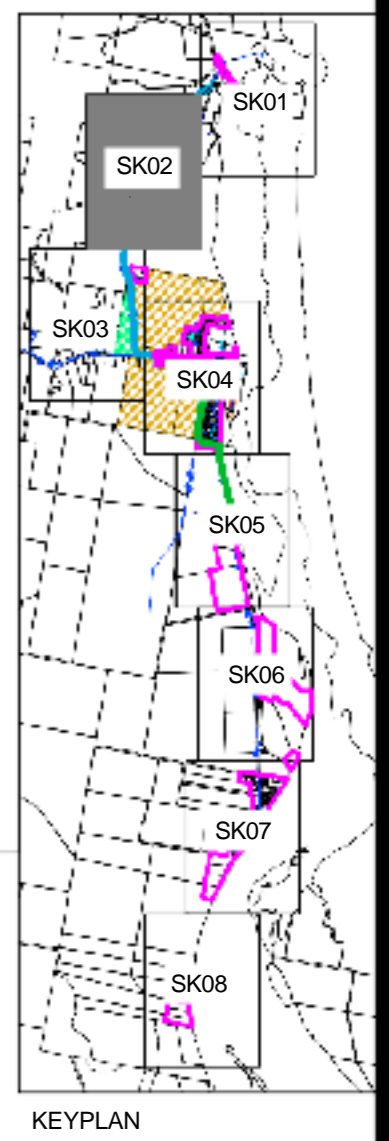
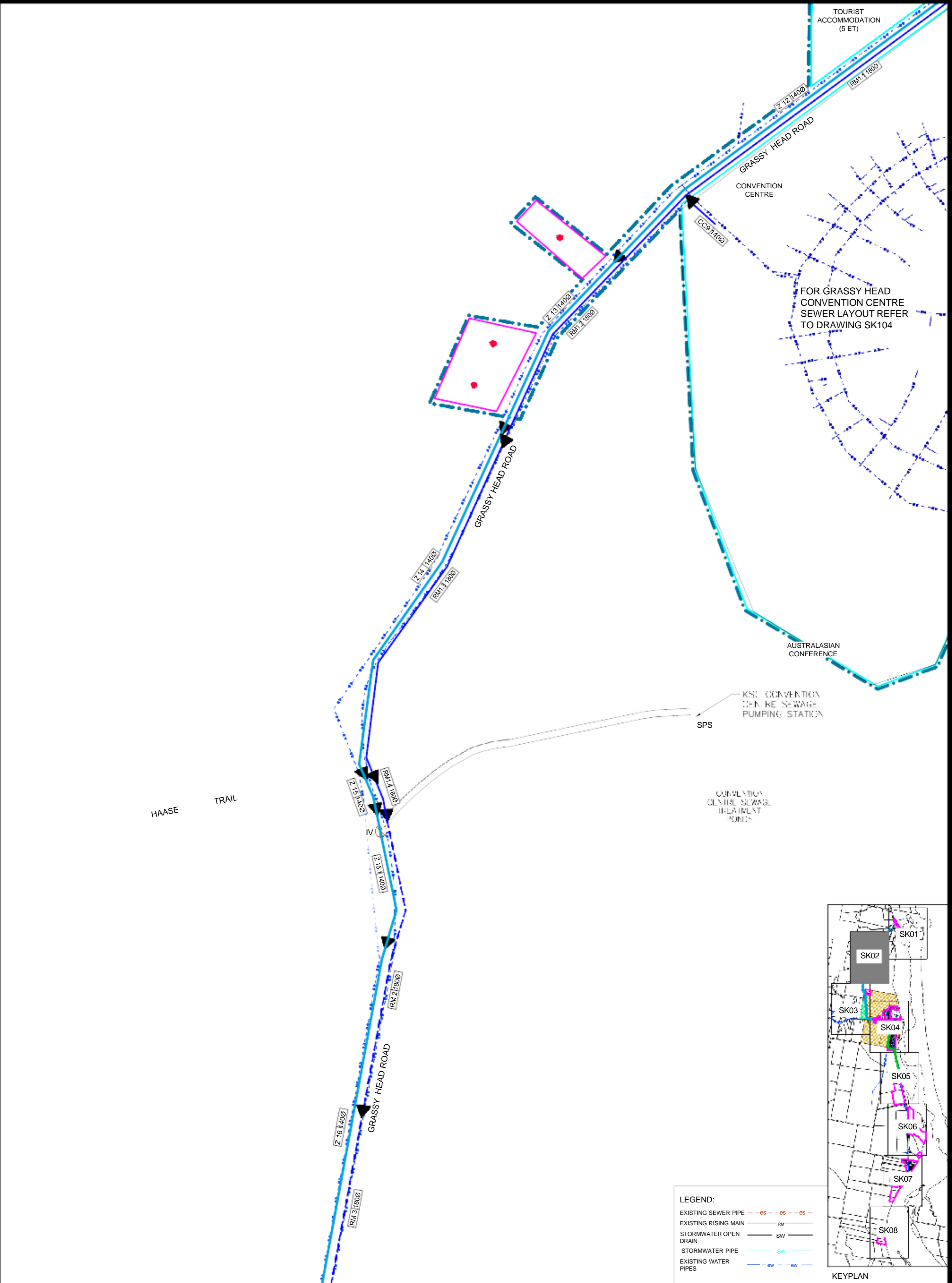

LEGEND:

- EXISTING SEWER PIPE - - - ES - - - ES - - - ES
- EXISTING RISING MAIN - - - RM - - - RM - - - RM
- STORMWATER OPEN DRAIN - - - SW - - - SW - - - SW
- STORMWATER PIPE - - - SW - - - SW - - - SW
- EXISTING WATER PIPES - - - EW - - - EW - - - EW

Drawing No: SK02
 Rev: D
 Date: 19/11/2021
 Scale: 1:2000 AT A1

STUARTS POINT

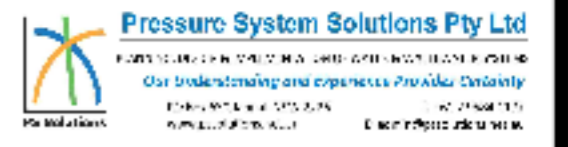

C:\Users\Valued Customer\Documents\210701 Stuarts Point\Street Mains\210624_SK00_SK08-[D].dwg

JOINS SHEET SK03

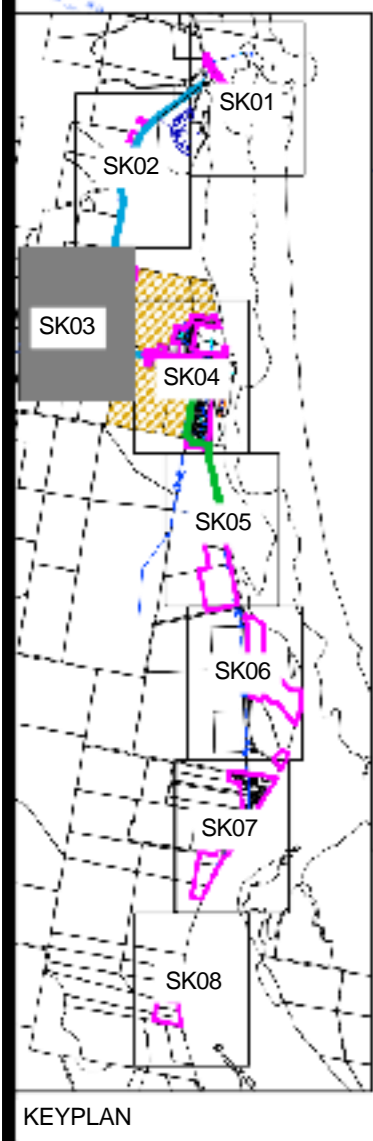
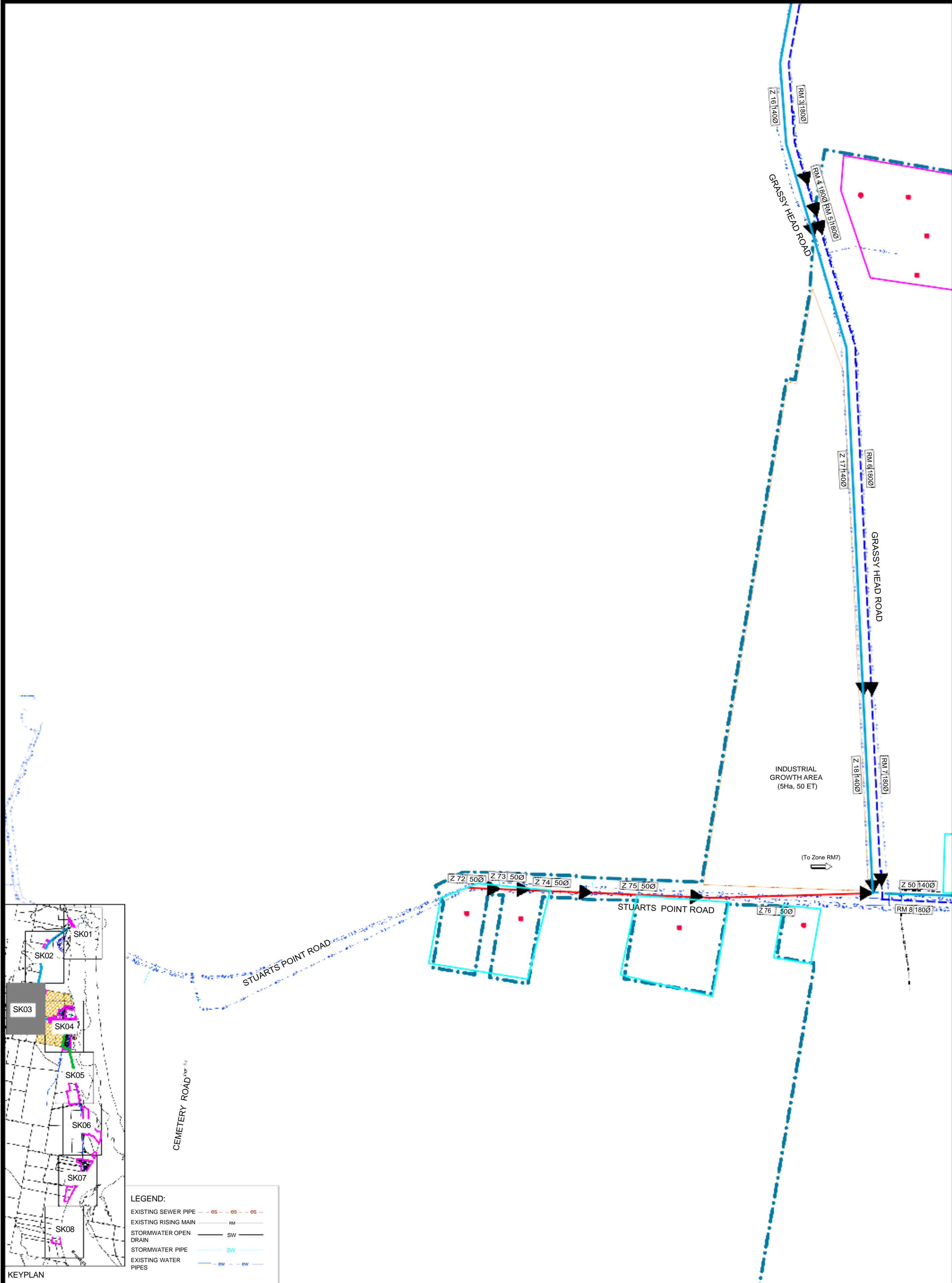

LEGEND:

EXISTING SEWER PIPE	— ES — ES — ES —
EXISTING RISING MAIN	— RM —
STORMWATER OPEN DRAIN	— SW —
STORMWATER PIPE	— SW —
EXISTING WATER PIPES	— EW — EW —

Drawing No: SK03
 Rev: D
 Date: 19/11/2021
 Scale: 1:2000

STUARTS POINT

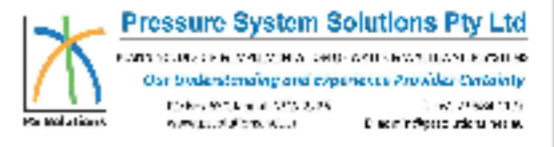

Saved: 19/11/2021, By: valued customer, C:\Users\Valued Customer\Documents\210701-Stuarts Point\Street Mains\210624_SK00_SK08-[D].dwg

JOINS SHEET SK04

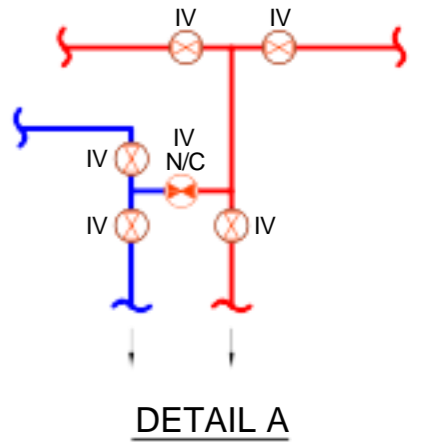

NORTH FUTURE
RESIDENTIAL GROWTH AREA
(56Ha, 560 ET)

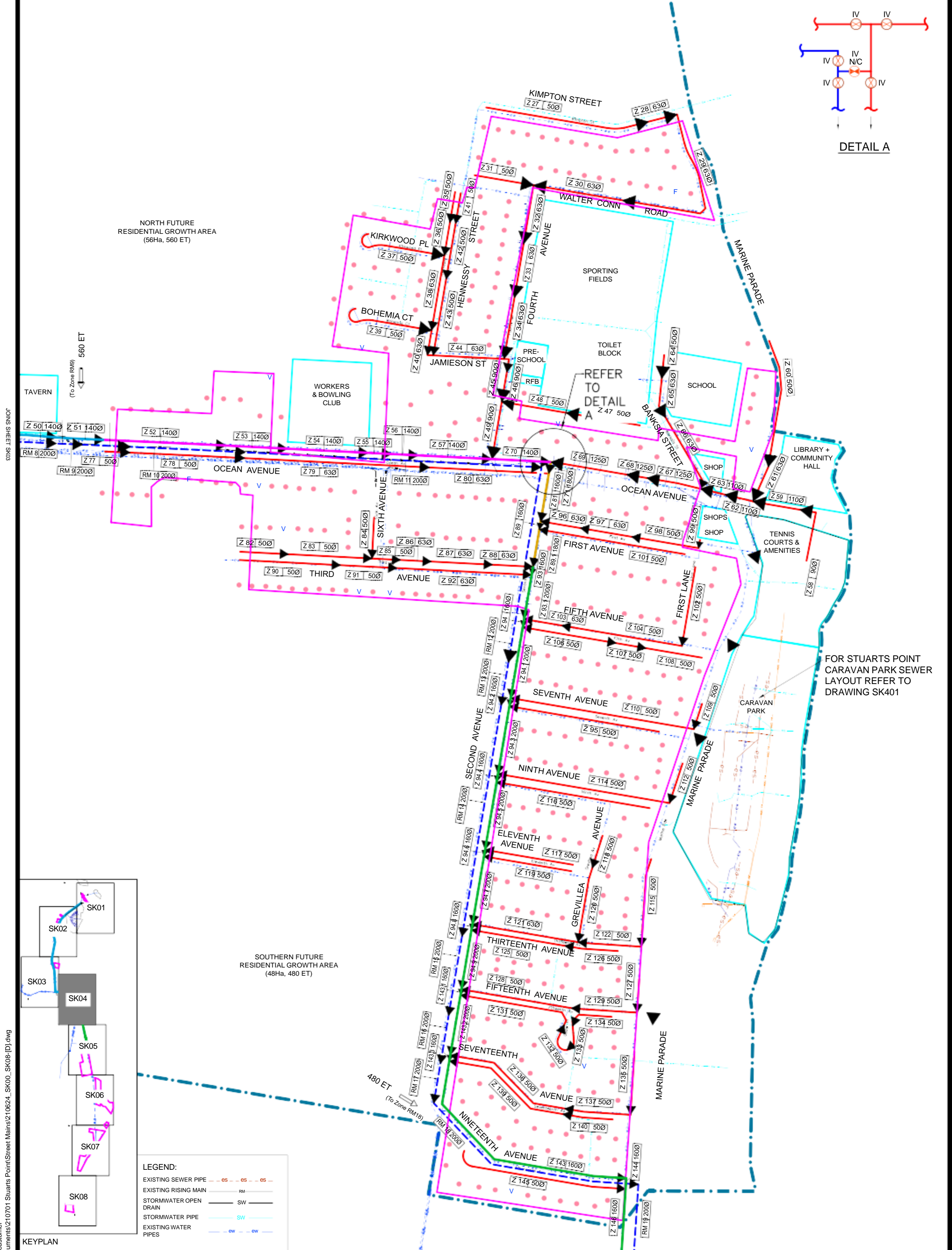

FOR STUARTS POINT
CARAVAN PARK SEWER
LAYOUT REFER TO
DRAWING SK401

60x85 SHEETS SNI001

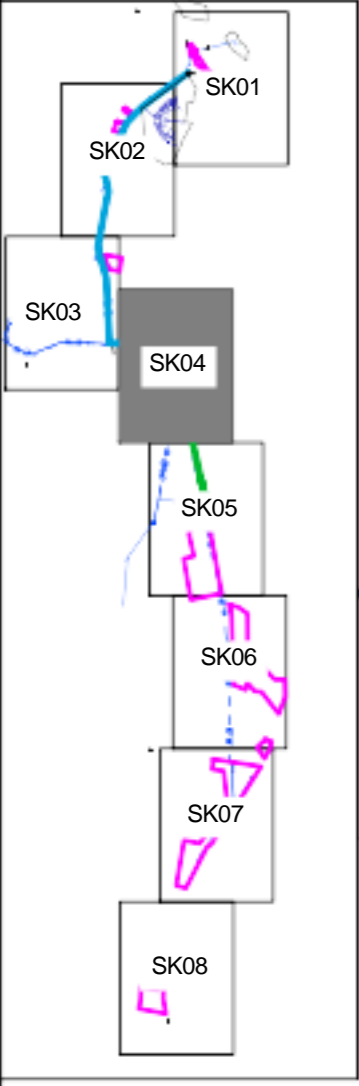

LEGEND:

EXISTING SEWER PIPE	— ES — ES — ES —
EXISTING RISING MAIN	— RM —
STORMWATER OPEN DRAIN	— SW —
STORMWATER PIPE	— SW —
EXISTING WATER PIPES	— EW — EW —

Drawing No: SK04

Rev: D

Date: 19/11/2021

Scale: 1:2000 AT A1

STUARTS POINT

CONCEPT DESIGN

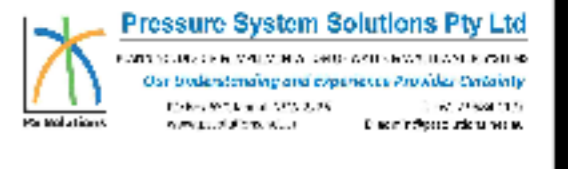

Saved: 19/11/2021, By: valued customer
C:\Users\valued customer\Documents\210701 Stuar...Point\Street Mains\210624_SK00_SK08-[D].dwg

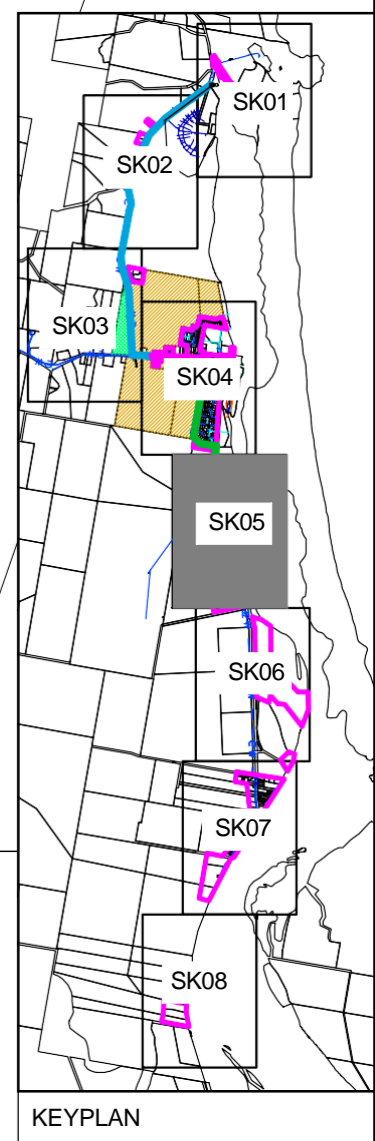
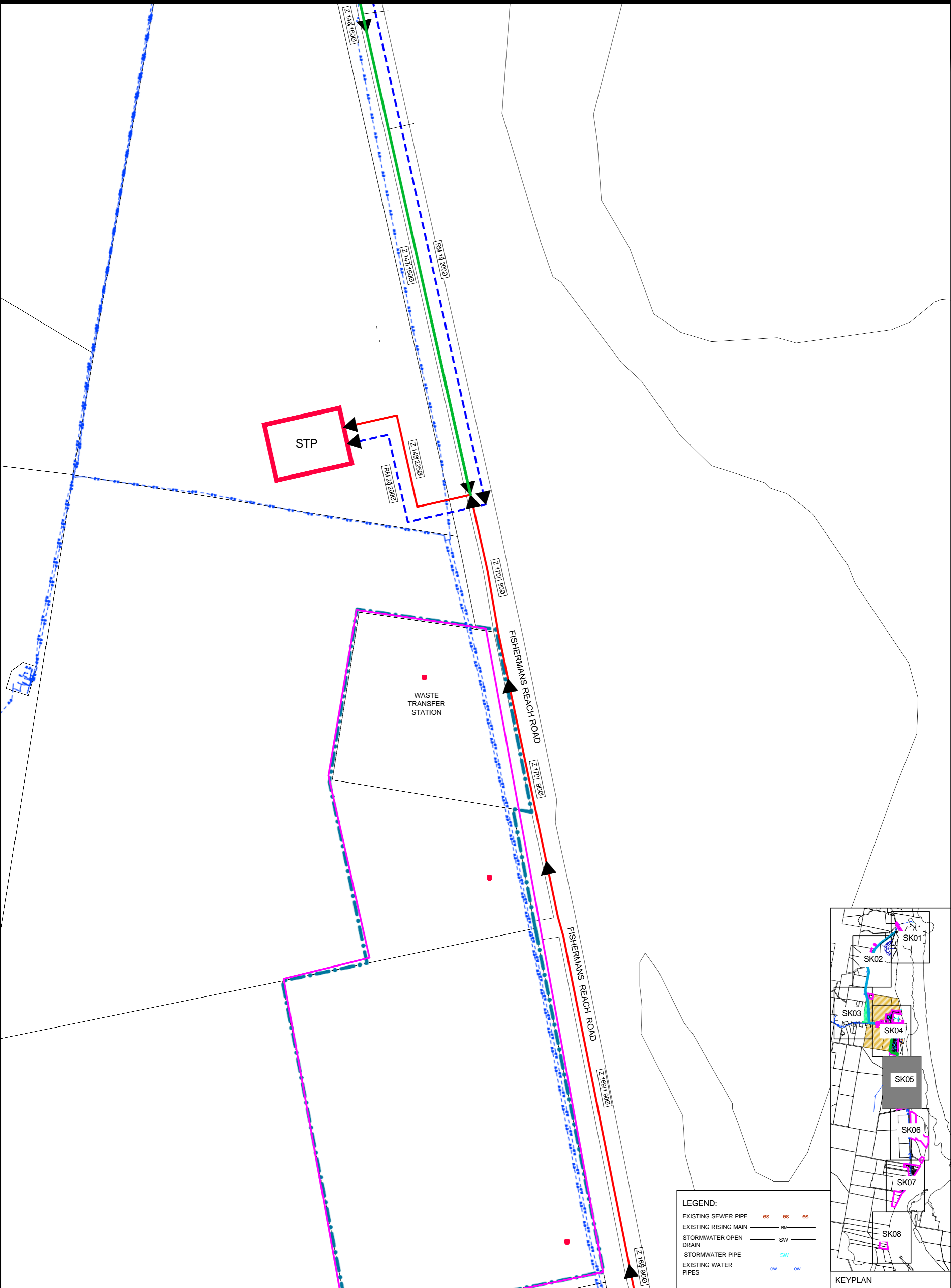

LEGEND:

- EXISTING SEWER PIPE - - - - ES - - - - ES
- EXISTING RISING MAIN - - - - RM
- STORMWATER OPEN DRAIN - - - - SW
- STORMWATER PIPE - - - - SW
- EXISTING WATER PIPES - - - - EW

Drawing No: SK05
 Rev: D
 Date: 19/11/2021
 Scale: 1:2000 AT A1

STUARTS POINT
- OPTION 1

CONCEPT

Saved: 19/11/2021, By: valued customer
 C:\Users\Valued Customer\Documents\210701 Stuarsts Point\Street Mains\210624_SK00_SK08-[D].dwg

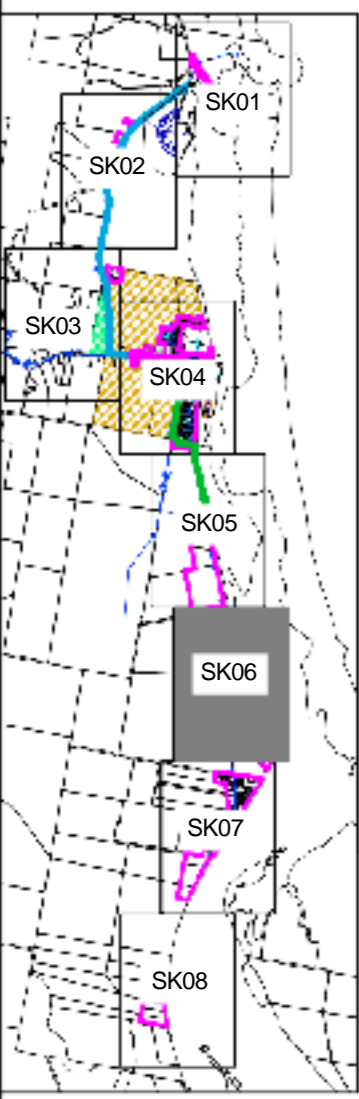

LEGEND:

EXISTING SEWER PIPE	- - - ES - - - ES - - - ES - - -
EXISTING RISING MAIN	RM
STORMWATER OPEN DRAIN	SW
STORMWATER PIPE	SW
EXISTING WATER PIPES	EW

Drawing No: SK06

Rev: D

Date: 19/11/2021

Scale: 0 20 40 60 80 100m
SCALE 1:2000 AT A1

STUARTS POINT

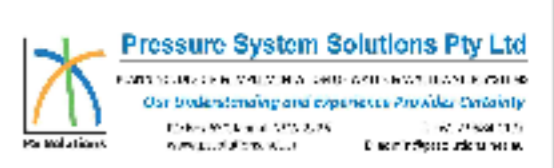

Saved: 19/11/2021, By: valued customer
C:\Users\Valued Customer\Documents\210701 Stuar... Point\Street Mains\210624_SK00_SK08-[D].dwg

SERRATA LANE

FISHERMANS REACH ROAD

FISHERMANS TRAIL

PERRETT LANE

FISHERMANS REACH ROAD

FISHERMANS REACH ROAD

LEGEND:

EXISTING SEWER PIPE	es	es	es
EXISTING RISING MAIN	RM		
STORMWATER OPEN DRAIN	SW		
STORMWATER PIPE	sw		
EXISTING WATER PIPES	ew	ew	

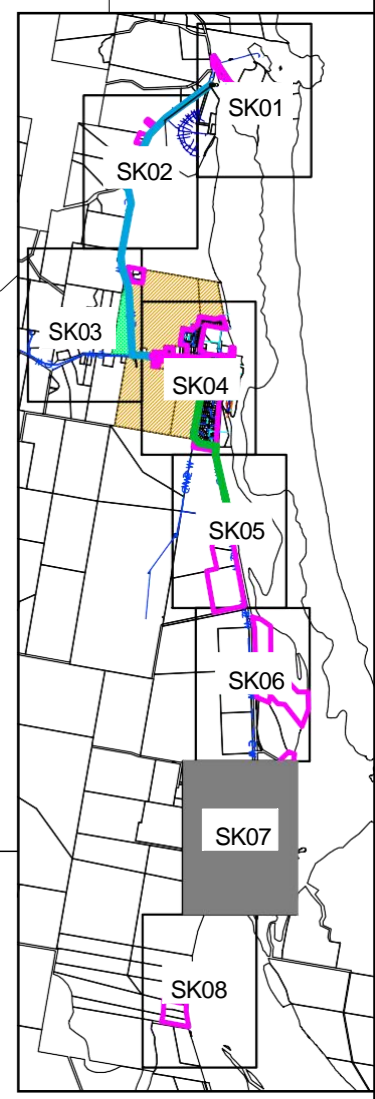

JOINS SHEET SK08

Drawing No: SK07

Rev: D

Date: 19/11/2021

Scale: SCALE 1:2000 AT A1

STUARTS POINT

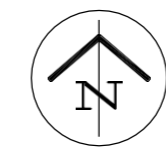

CONCEPT

Pressure System Solutions Pty Ltd
 PLANNING, DESIGN & IMPLEMENTATION OF WATER & WASTEWATER SYSTEMS
Our Understanding and Experience Provides Certainty
 PO Box 630 Jannali NSW 2226 T: +61 2 9584 1177
 www.pssolutions.net.au E: admin@pssolutions.net.au

Saved: 19/11/2021, By: valued customer C:\Users\Valued Customer\Documents\210701 Stuarts Point\Street Mains\210624_SK00_SK08-[D].dwg

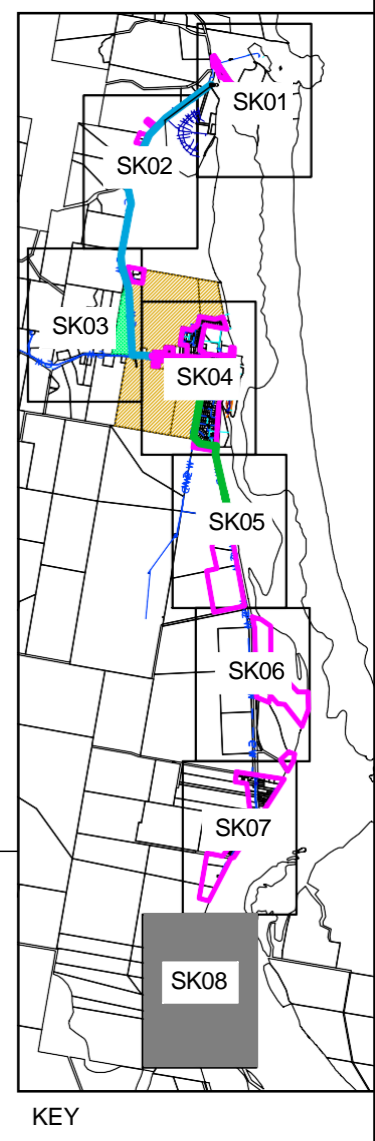
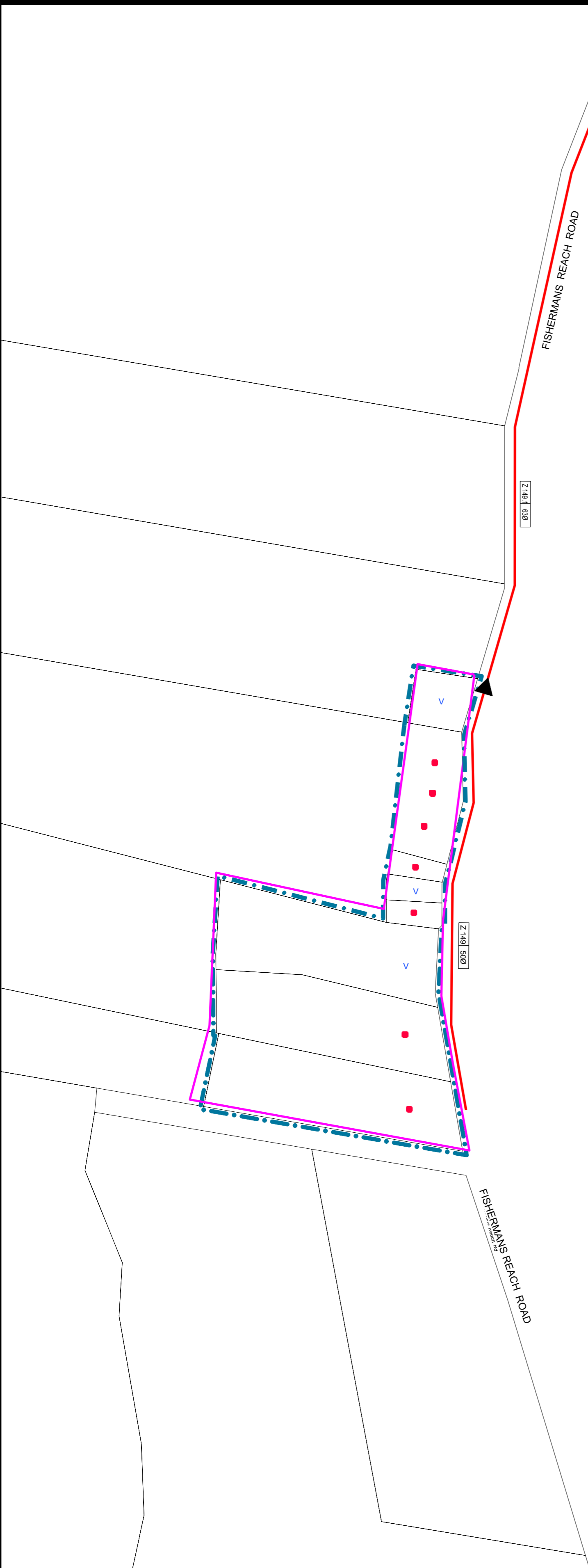

LEGEND:

EXISTING SEWER PIPE	- - GS - - GS - - GS - - GS - - GS - -
EXISTING RISING MAIN	RM
STORMWATER OPEN DRAIN	SW
STORMWATER PIPE	SW
EXISTING WATER PIPES	GW

Drawing No: SK08
 Rev: D
 Date: 19/11/2021
 Scale: SCALE 1:2000 AT A1

STUARTS POINT



Saved: 19/11/2021, By: valued customer
 C:\Users\Valued Customer\Documents\210701 Stuarsts Point\Street Mains\210624_SK00_SK08-[D].dwg

